

Product Specifications



USHIBAY100WEGEL

FEATURES

- System Light Efficacy 120 LPW
- Flexible, Modular Design
- Easy Installation & Maintenance
- IP66
- Five Years Warranty
- ETL, CE, RoHS, CB, WEEE

TYPICAL APPLICATIONS

- Warehouse/Manufacturing Facilities
- Convention Centers/Sporting Arenas
- Big-Box Retail Stores
- Cold Storage Facilities
- Gymnasiums

SPECIFICATIONS

PERFORMANCE

LED Chip	OSRAM
Lumen Output (IES)	12,000 lm
Power Consumption	100 W
Efficacy (IES)	120 lm/W
Beam Angle	70/135°, 30/100°, 90°, 110°, 150°, 60/100°
Color Temperature	4500~5500K (2500~5500K Optional)
CRI	≥70
Lumen Maintenance	L70>100,000 hours (Calculated Using TM-21 Calculator)
Input Voltage	100-277 VAC (347/480 VAC Optional) Dimming Optional
Power Factor	0.95 minimum

ENVIRONMENTAL

IP Rating	IP66
Operating Temperature	-30 to 45°C (-22 to 113°F)
Storing Temperature	-40 to 80°C (-40 to 167°F)
Humidity	15% to 95% RH

PHYSICAL

Dimensions (L×W×H)	330×365×224 mm (13.0×14.4×8.8 in) (U Bracket)
Weight	6.4 kg (14.1 lbs) (U Bracket)
Mounting Options	Hook/Chain Mount, Surface Mount Universal Hanging Bracket
Fixture Material	Aluminum Alloy

WARRANTY

5 Years

70×135 DEGREE LENS (Forward 5°)

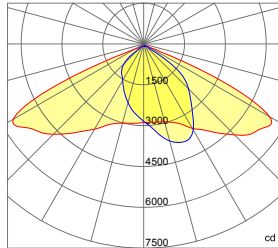

— 0.0~180.0
— 90.0~270.0

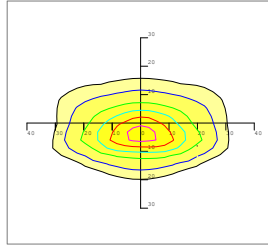

Mounting Height 10m, 0 Tilt,
20LUX-0.2LUX

Illumination-70/135 Degree Beaming Angle

Height	Rectangular Light Spot	LUX
2m	1.8×2.1m	715LUX
4m	3.6×4.2m	179LUX
6m	5.4×6.3m	80LUX
8m	7.2×8.3m	45LUX
10m	9.0×10.4m	29LUX

Beam Angle (50% max)	70×135 DEG
Luminous Flux (IES)	12,000 lm
Light Efficacy (IES)	120 lm/W
Cutoff Classification	Cutoff

30×100 DEGREE LENS

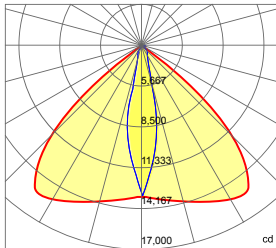

— 0.0~180.0
— 90.0~270.0

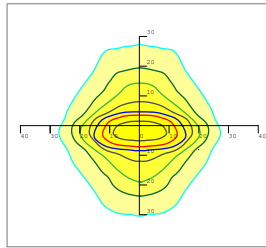

Mounting Height 10m, 0 Tilt,
20LUX-0.2LUX

Illumination-30/100 Degree Beaming Angle

Height	Rectangular Light Spot	LUX
2m	0.9×4.5m	3491LUX
4m	1.9×8.9m	873LUX
6m	2.8×13.4m	388LUX
8m	3.7×17.9m	218LUX
10m	4.7×22.3m	140LUX

Beam Angle (50% max)	30×100 DEG
Luminous Flux (IES)	12,000 lm
Light Efficacy (IES)	120 lm/W
Cutoff Classification	Cutoff

90 DEGREE LENS

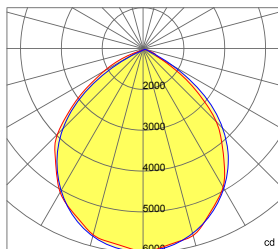

— 0.0~180.0
— 90.0~270.0

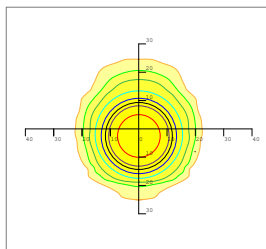

Mounting Height 10m, 0 Tilt,
20LUX-0.2LUX

Illumination-90 Degree Beaming Angle

Height	Beam Diameter	LUX
2m	φ4.4m	1486LUX
4m	8.7×8.9m	372LUX
6m	13.1×13.3m	165LUX
8m	17.4×17.7m	93LUX
10m	21.8×22.2m	60LUX

Beam Angle (50% max)	90 DEG
Luminous Flux (IES)	12,000 lm
Light Efficacy (IES)	120 lm/W
Cutoff Classification	Cutoff

110 DEGREE LENS

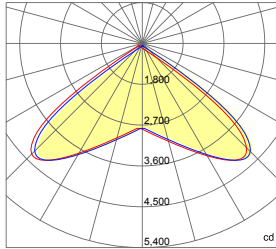

— 0.0~180.0
— 90.0~270.0

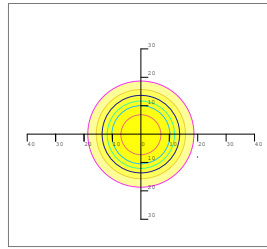

Mounting Height 10m, 0 Tilt,
20LUX-0.2LUX

Illumination-110 Degree Beaming Angle		
Height	Rectangular Light Spot	LUX
2m	4.0x4.3m	685LUX
4m	8.0x8.6m	171LUX
6m	12.0x13.0m	76LUX
8m	15.9x17.3m	43LUX
10m	19.9x21.6m	27LUX

Beam Angle (50% max)	110 DEG
Luminous Flux (IES)	12,000 lm
Light Efficacy (IES)	120 lm/W
Cutoff Classification	Cutoff

150 DEGREE LENS

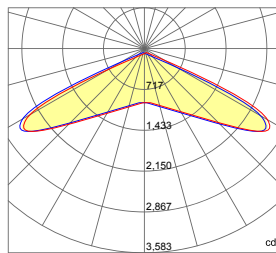

— 0.0~180.0
— 90.0~270.0

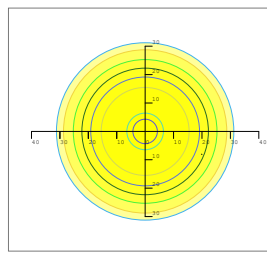

Mounting Height 10m, 0 Tilt,
20LUX-0.2LUX

Illumination-150 Degree Beaming Angle		
Height	Rectangular Light Spot	LUX
2m	1.8x5.3m	334LUX
4m	3.7x10.7m	84LUX
6m	5.5x16.0m	37LUX
8m	7.4x21.4m	21LUX
10m	9.2x26.7m	13LUX

Beam Angle (50% max)	150 DEG
Luminous Flux (IES)	12,000 lm
Light Efficacy (IES)	120 lm/W
Cutoff Classification	Cutoff

60 x 100 DEGREE LENS

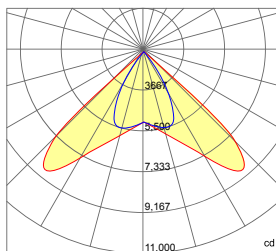

— 0.0~180.0
— 90.0~270.0

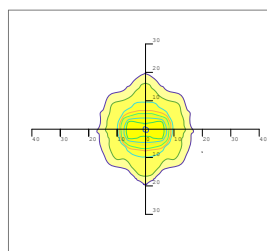

Mounting Height 10m, 0 Tilt,
20LUX-0.2LUX

Illumination-60x100 Degree Beaming Angle		
Height	Rectangular Light Spot	LUX
2m	1.5x2.2m	1165LUX
4m	2.9x4.4m	291LUX
6m	4.4x6.6m	130LUX
8m	5.8x8.7m	73LUX
10m	7.3x10.9m	47LUX

Beam Angle (50% max)	60x100 DEG
Luminous Flux (IES)	12,000 lm
Light Efficacy (IES)	120 lm/W
Cutoff Classification	Cutoff

Microwave Sensor & Dimmer Option



Technical Data			
Operating voltage	120-277V	Standby power	approx. 0.5W
Switched power	Max.capacitive load: 800W @277V, 400W@120V	Heating time	20s
Detection area	10/50/75/100%, can be customized	Sensor principle	Microwave motion
Hold time	5S/30S/1min/5min/10min/20min/30min, can be customized	Microwave frequency	5.8GHz+/-75MHz
Standby period	0s/10s/1min/5min/10min/30min/1h/+∞can be customized	Microwave power	<0.2mw
Standby dimming level	10%/20%/30%/50% can be customized	Detection range	Max. (φxH):18m x 10m
Daylight threshold	2~50lux daylight/twilight/darkness, can be customized	Detection angle	30° ~ 150°
Operating temperature	-35°C ~ +70°C	Mounting height	Max.10m
IP rating	IP20, IP65(mounting in Hytronik special box)	Certificate	ETL, FCC

Detection Pattern

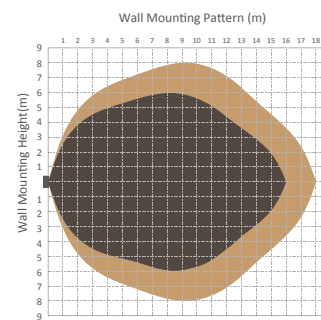
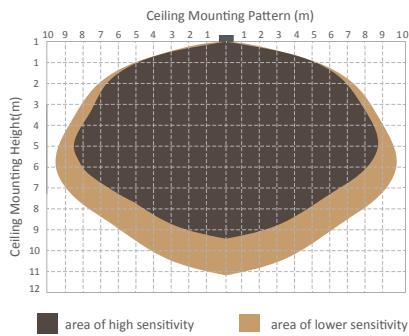

Setting

	Detection Area			Hold-time			Daylight Sensor			Stand-by Period (Corridor function)			Stand-by Dimming Level				
	1	2		1	2	3	1	2		1	2	3		1	2		
I	●	●	100%	●	●	●	5s	●	●	Disable	●	●	●	0s	●	●	10%
II	●	○	75%	●	●	○	30s	●	○	50lux	●	●	○	10s	●	○	20%
III	○	●	50%	●	○	●	1min	○	●	10lux	●	○	●	1min	○	●	30%
IV	○	○	10%	●	○	○	5min	○	○	2lux	●	○	●	5min	○	○	50%
V				○	●	●	10min				○	●	●	10min			
VI				○	●	○	20min				○	●	○	30min			
VII				○	○	○	30min				○	○	●	1h			
VIII											○	○	○	+∞			

- Detection area can be reduced by selecting the combination on the DIP switches to fit precisely for each specific application.
- Hold-time means the time period you would like to keep the lamp on 100% after the person has left the detection area.
- The daylight threshold can be set on DIP switches, to fit for particular application.
- This is the time period you would like to keep at the low light output level before it is completely switched off in the long absence of people. Note: 0 means on/off control; +∞ means 2 steps of dimming control, fixture never switch off.
- This is the dimmed low light output level you would like to have after the hold-time in the absence of people.

Infrared Sensor & Dimmer Option



Technical Data	
<ul style="list-style-type: none"> 120/277 VAC, 50/60Hz - Load @120 VAC 0-800W Ballast or Incandescent - Load @277 VAC 0-1200W Ballast 	<ul style="list-style-type: none"> Sensitivity: None, Low, Med, Max; Default Max Setpoint: None, 1-250 fc, Auto; Default 4 fc Ramp up time: None, 1-60 sec.; Default None
<ul style="list-style-type: none"> 230 VAC, 50Hz; Load 0-300W Ballast 	<ul style="list-style-type: none"> Fade Down Time: None, 1-60 sec.; Default None Operating Temperature: -40-167°F (-40-75°C) Operating Humidity: 20-90%
<ul style="list-style-type: none"> Relay Life Rating: 200,000 Cycles (120/277 VAC); 50,000 Cycles (230 VAC) 	<ul style="list-style-type: none"> Weight: 2.8 oz (80 grams) IP66, CE Compliant TUV, UL and cUL Listed
<ul style="list-style-type: none"> High Mode: 0-10 V; Default 10 V Low Mode: Off, 0-9.8 V; Default 1 V Time Delay: 30 Sec., 5-30 min.; Default 5 min. Cut Off Delay: None, 1-60 min. 1-5 hrs.; Default 1hr. 	<ul style="list-style-type: none"> Five Year Warranty

Coverage Pattern

Density and range of the coverage pattern are determined by the type of lens and mounting height

L3: 360° Coverage

L3 has a high density lens that covers a 40' diameter area at a height of 20'.

FSP-L3 High Density/Reduced Range Lens

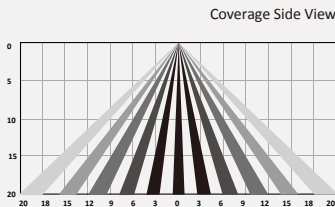
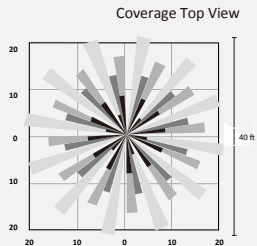
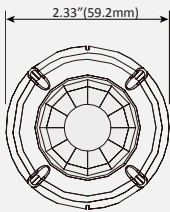

L2: 360° Coverage

L2 lens provides a 44' diameter coverage area when mounted at a height of 8'.

L2 Low Density/Wide Range Lens

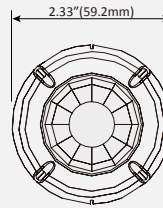

Coverage Top View

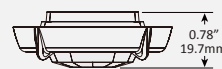
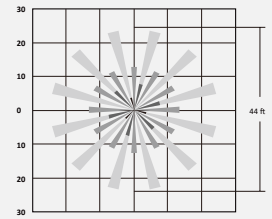

Coverage Side View



L4: 360° Coverage

L4 is designed for mounting at heights between 30' to 40'. Its coverage area can be up to 60' in diameter when mounted at 40'.

L4 40 Foot High Bay Lens

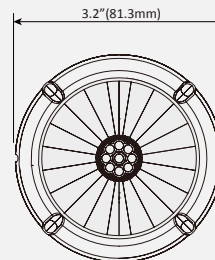

Coverage Top View

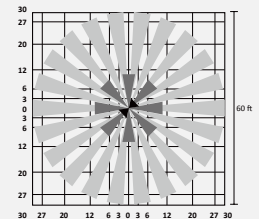

Coverage Side View

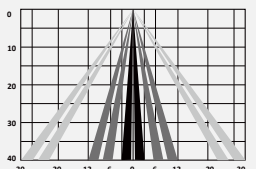

Setting

Refer to Dimmer&Remotion operation guidance.

U Bracket+Hanging Ring

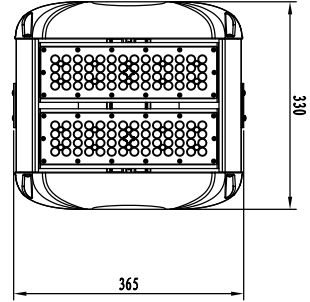
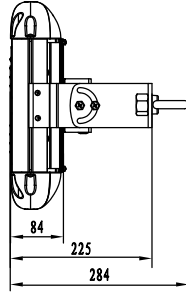

U Bracket, Long Axial Mount

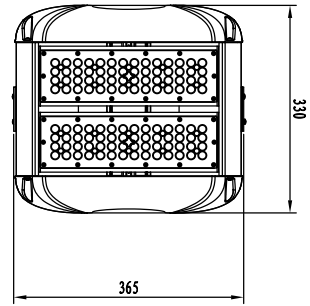
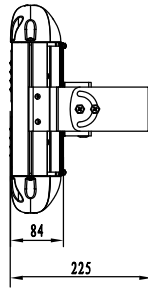

Surface Mount Bracket

